

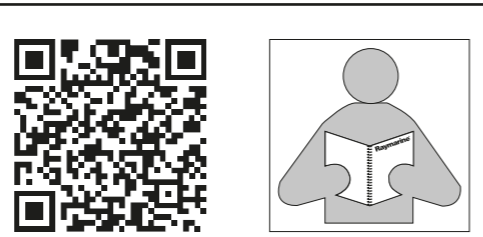

# AX8

**Quick Start Guide**  
 Document number: 88050-3-EN  
 Date: 09-2015

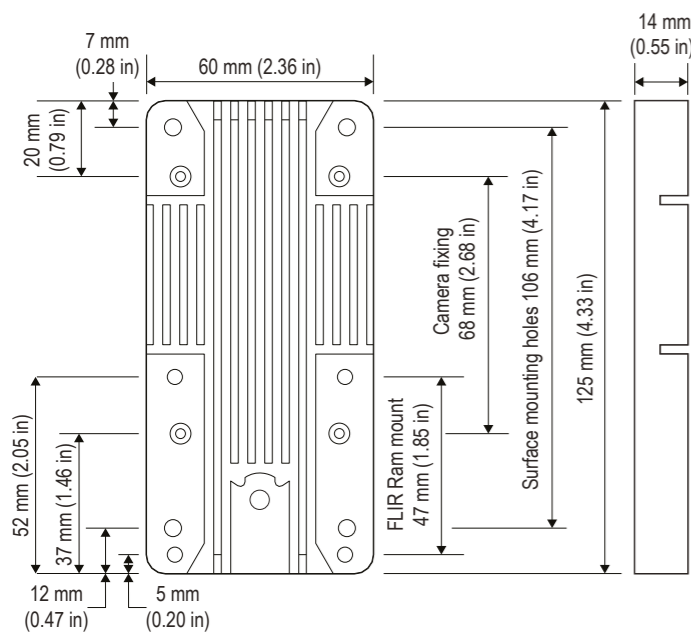
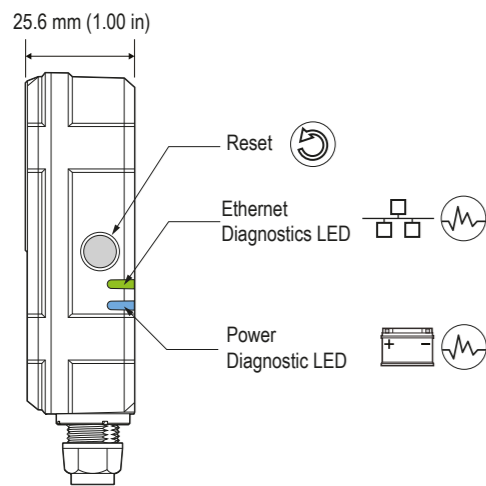
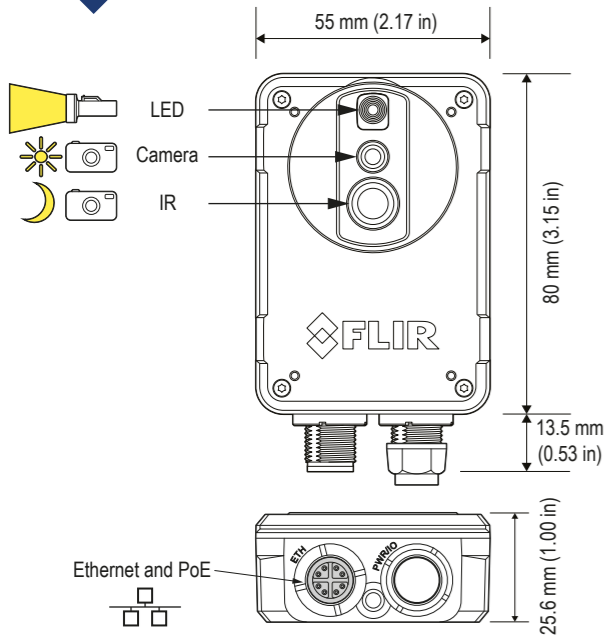

Obtain the complete documentation for your product. The supplied printed documentation is a subset of the full documentation available for your product.

**Important:** The latest versions of all English and translated handbooks are available on the Raymarine website. Please check the website to ensure you have the latest and complete documentation and safety information for your product.  
<http://www.raymarine.com/manuals>



**Software requirements:**  
 Your Raymarine Multifunction display must be running LightHouse™ II Release 15.xx or greater.  
<http://www.raymarine.com/software>

## Set-up

The AX8's built-in web interface MUST be used to align the thermal and visible images before using **Thermal MSX®** mode and to set-up spot alarms. The web interface also provides access to other features and settings not available on your MFD.

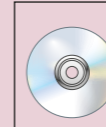

Refer to the FLIR AX Series user manual (T559913), available on the supplied CD for full details of the features and settings available from the web interface.

- 1 Connect the AX8 to your MFD network and ensure it is powered.

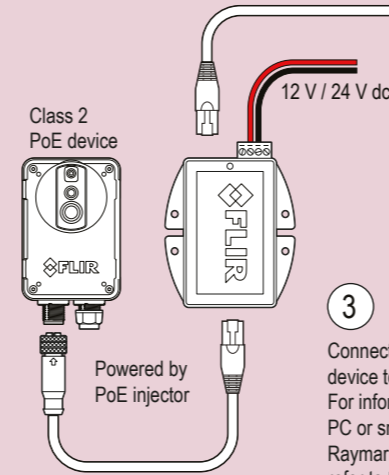

- 3

Connect your PC or smart device to the MFD network. For information on connecting a PC or smart device to your Raymarine MFD network, refer to the **LightHouse Operation instructions (81360)**.

### Raymarine LightHouse MFD



- 2

Obtain the AX8's IP address, this can be found by accessing the AX8's diagnostics page using a Raymarine LightHouse MFD. **Homescreen > Set-up > Maintenance > Diagnostics > Select Device > AX8.** Scroll down to Networks, the IP address is part of the RTSP URL.

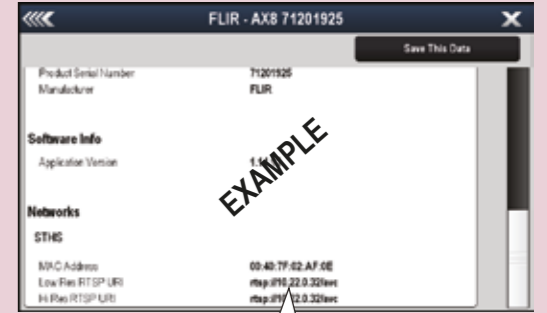

**EXAMPLE**

rtsp://10.22.0.32/avc

- 4

Enter the AX8's IP address in the web browser's address bar on your connected PC or smart device.

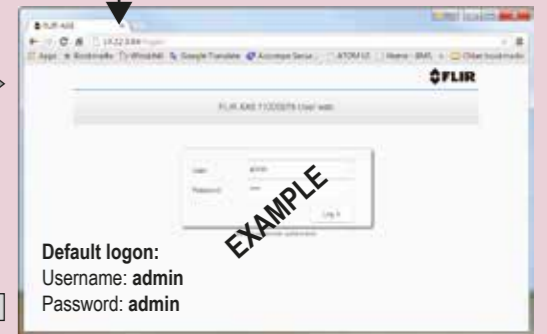

**EXAMPLE**

- 5

When using the camera in **Thermal MSX®** mode, you can use the "Adjust Distance" slider control in the web interface to adjust the overlay position of the visible Vs. the thermal image.

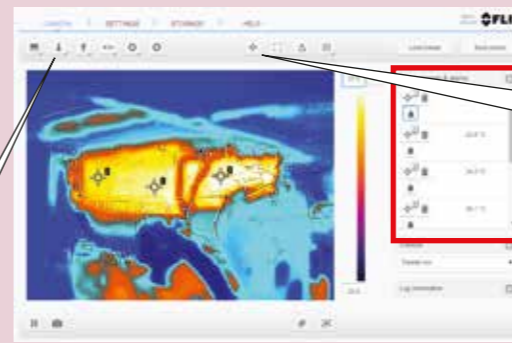

- 6

Select the Spot alarm icon to add a new spot to the image, drag the spot to the required position and then set the temperature alarm by selecting the bell icon.

Alternatively you can connect the AX8 directly to a PC using an ethernet (RJ45) cable. To obtain the AX8's IP address using a PC download and install the **FLIR IP Config** tool version 1.9 or greater.  
<http://tinyurl.com/o5wudd7>

## Connections to a Raymarine MFD

The AX8 can be powered using the supplied PoE injector, alternatively, it can also be powered by a Raymarine MFD / network switch capable of providing power over ethernet (PoE).

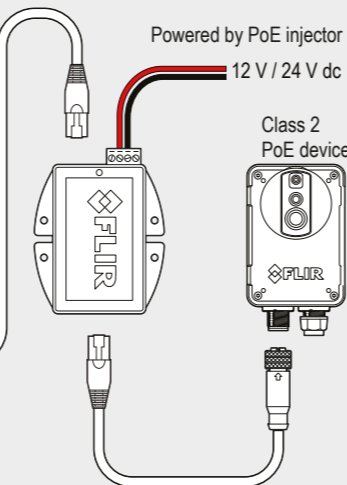

**Potential ignition source**  
 The PoE injector is NOT approved for use in hazardous/flammable atmospheres. Do NOT install in a hazardous/flammable atmosphere (such as in an engine room or near fuel tanks). In this scenario, you can use a female to male RJ45 adapter cable (available separately) to extend the cable run between the AX8 and the PoE injector.

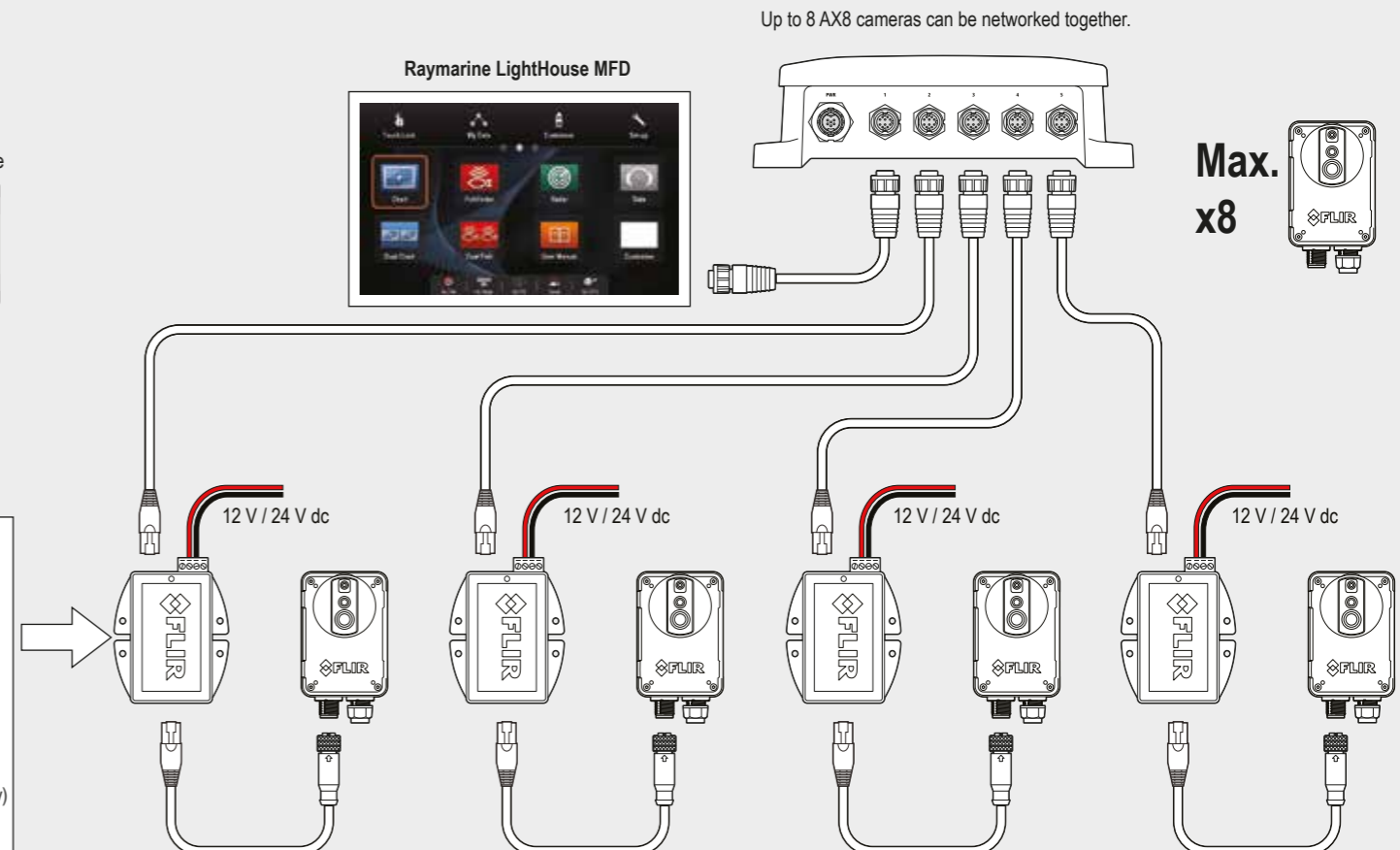

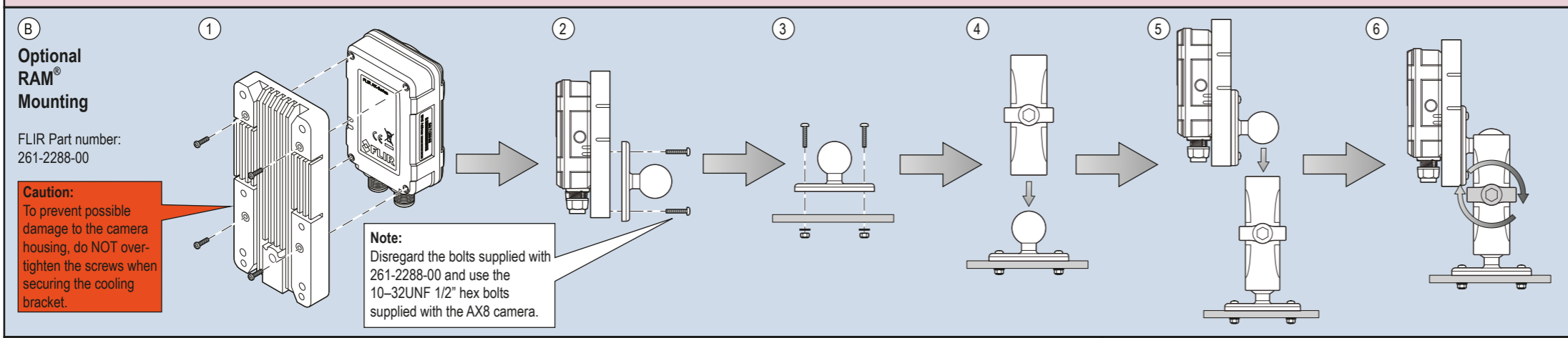
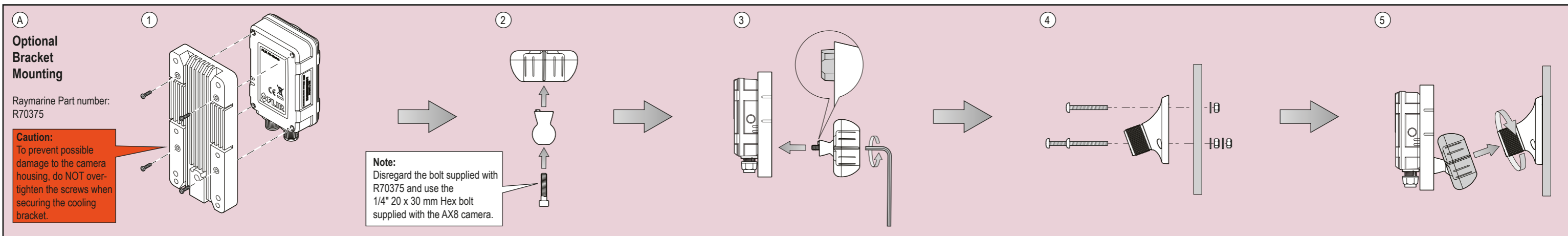

**Mounting options**

All mounting options require the supplied cooling bracket to be fitted to the AX8 before installation.

A) Bracket mounting (using optional Raymarine accessory R70375) ;  
B) RAM® mounting (using optional FLIR accessory 261-2288-00) ;  
C) Surface mounting.

**Important:** Before mounting the camera check the desired location, ensuring that the area or objects to be monitored are within the camera's field of view and that any spot alarms are correctly placed.

Consider using the FLIR ONE™ to survey the best location for your AX8 prior to installation. <http://www.flir.com/flirone/>

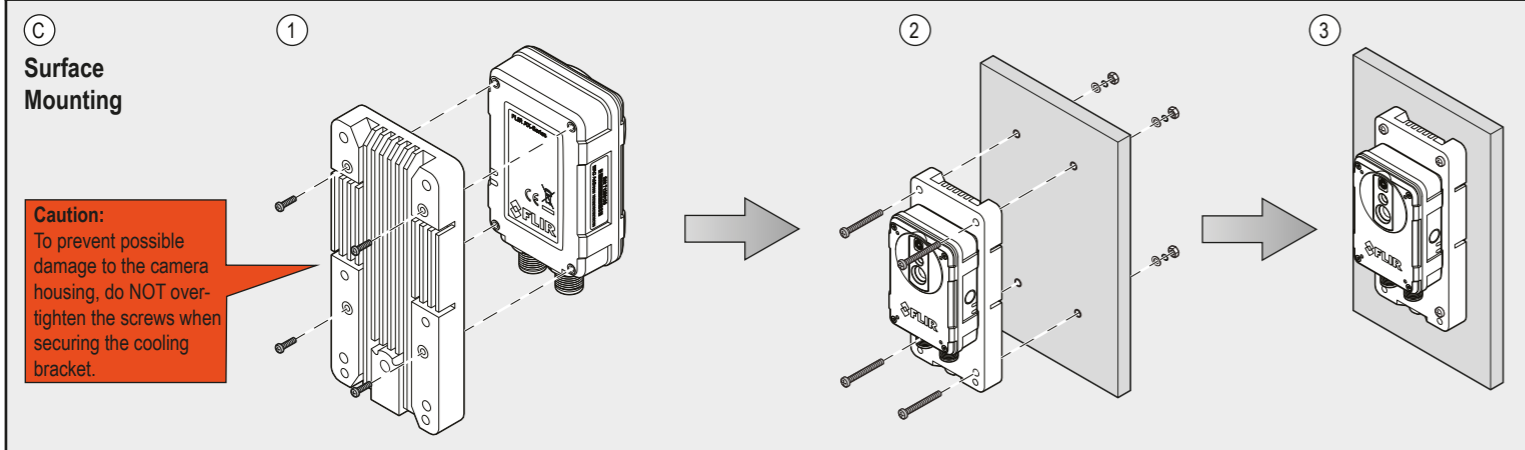

**Operations / Monitoring**

**Important:** Refer to the LightHouse™ MFD operation instructions (81360) for details on operating your AX8 using your Raymarine Multifunction Display (MFD). Visit the website to download the document. <http://www.raymarine.com/manuals>

Raymarine LightHouse MFD

Monitor feeds and spot readings using the Camera application

**Alarms**  
Enable AX8 spot alarms on your Raymarine MFD. (Spot alarms MUST be set-up using the AX8's web interface.)

**LED light**  
Switch the camera's LED light on and off directly from your Raymarine MFD's Camera application menu: Menu > Adjust > Light.

**Selecting the image mode**  
Switch image mode directly from your Raymarine MFD's Camera application menu.

**Thermal MSX®**

**Thermal**

**Visible**